



**Technical and Test Institute
for Construction Prague**
Prosecká 811/76a
190 00 Prague
Czech Republic
eota@tzus.cz



Member of



www.eota.eu

European Technical Assessment

**ETA 21/0250
of 17/08/2021**

Technical Assessment Body issuing the ETA: Technical and Test Institute
for Construction Prague

Trade name of the construction product

ICFS CM 385 PE PRO
ICFS CM 585 PE PRO

**Product family to which the construction
product belongs**

Product area code: 33
Bonded injection type anchor for use in
cracked and uncracked concrete

Manufacturer

INDO CONSTRUCTION FASTENING
SYSTEMS (ICFS) INDO - SPARK
CONSTRUCTION SERVICES
198 E, TARARANI CHOWK, NEAR GEETA
MANDIR, KOLHAPUR 416003,
MAHARASHTRA, INDIA

Manufacturing plant

INDO CONSTRUCTION FASTENING
SYSTEMS (ICFS) INDO – SPARK plant 1

**This European Technical Assessment
contains**

20 pages including 17 Annexes which form
an integral part of this assessment.

**This European Technical Assessment is
issued in accordance with regulation
(EU) No 305/2011, on the basis of**

EAD 330499-01-0601
Bonded fasteners for use in concrete

This version replaces

ETA 21/0250 issued on 08/04/2021

Translations of this European Technical Assessment in other languages shall fully correspond to the original issued document and should be identified as such.

Communication of this European Technical Assessment, including transmission by electronic means, shall be in full (excepted the confidential Annex(es) referred to above). However, partial reproduction may be made, with the written consent of the issuing Technical Assessment Body - Technical and Test Institute for Construction Prague. Any partial reproduction has to be identified as such.

1. Technical description of the product

The ICFS CM 385 PE PRO, ICFS CM 585 PE PRO with steel elements is bonded anchor (injection type).

Steel elements can be galvanized or stainless steel threaded rods or rebars.

Steel element is placed into a drilled hole filled with injection mortar. The steel element is anchored via the bond between metal part, injection mortar and concrete. The anchor is intended to be used with various embedment depth up to 20 diameters.

The illustration and the description of the product are given in Annex A.

2. Specification of the intended use in accordance with the applicable EAD

The performances given in Section 3 are only valid if the anchor is used in compliance with the specifications and conditions given in Annex B.

The provisions made in this European Technical Assessment are based on an assumed working life of the anchor of 50 years and 100 years. The indications given on the working life cannot be interpreted as a guarantee given by the producer, but are to be regarded only as a means for choosing the products in relation to the expected economically reasonable working life of the works.

3. Performance of the product and references to the methods used for its assessment

3.1 Mechanical resistance and stability (BWR 1)

Essential characteristic	Performance
Characteristic resistance to tension load (static and quasi-static loading)	See Annex C 1, C 2
Characteristic resistance to shear load (static and quasi-static loading)	See Annex C 3, C 4
Displacements under short-term and long-term loading	See Annex C 5
Characteristic resistance and displacement for seismic performance categories C1 and C2	See Annex C 6, C 7, C 8

3.2 Hygiene, health and environment (BWR 3)

No performance determined.

3.3 General aspects relating to fitness for use

Durability and serviceability are only ensured if the specifications of intended use according to Annex B 1 are kept.

4. Assessment and verification of constancy of performance (AVCP) system applied with reference to its legal base

According to the Decision 96/582/EC of the European Commission¹ the system of assessment verification of constancy of performance (see Annex V to Regulation (EU) No 305/2011) given in the following table apply.

Product	Intended use	Level or class	System
Metal anchors for use in concrete	For fixing and/or supporting to concrete, structural elements (which contributes to the stability of the works) or heavy units	-	1

¹ Official Journal of the European Communities L 254 of 08.10.1996

5. Technical details necessary for the implementation of the AVCP system, as provided in the applicable EAD

The factory production control shall be in accordance with the control plan which is a part of the technical documentation of this European Technical Assessment. The control plan is laid down in the context of the factory production control system operated by the manufacturer and deposited at Technický a zkušební ústav stavební Praha, s.p.² The results of factory production control shall be recorded and evaluated in accordance with the provisions of the control plan.

Issued in Prague on 17.08.2021

By

Ing. Mária Schaan

Head of the Technical Assessment Body

² The control plan is a confidential part of the documentation of the European Technical Assessment, but not published together with the ETA and only handed over to the approved body involved in the procedure of AVCP.

Threaded rod

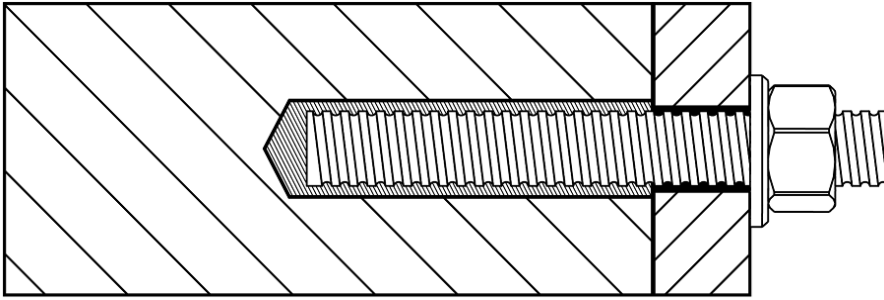

Reinforcing bar

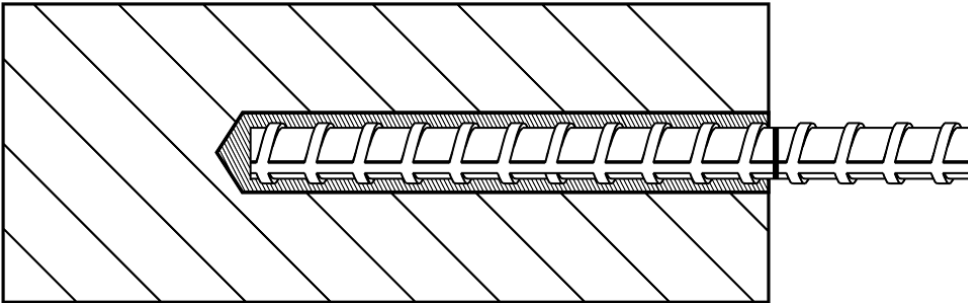

ICFS CM 385 PE PRO, ICFS CM 585 PE PRO

Product description
Installed conditions

Annex A 1

Mortar cartridges

Side by side cartridge

ICFS CM 385 PE PRO,
ICFS CM 585 PE PRO

385 ml
585 ml

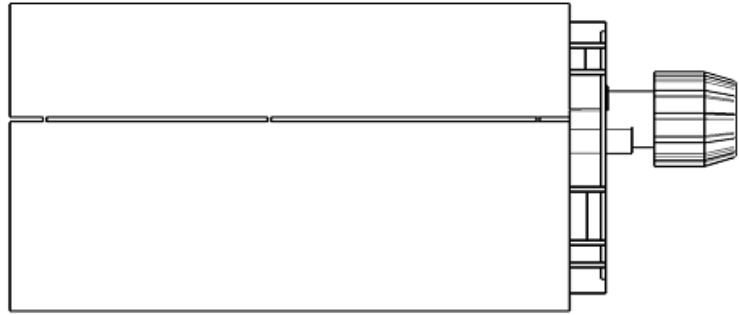

Marking of the mortar cartridges

Identifying mark of the producer, Trade name, Charge code number, Storage life, Curing and processing time

Mixing nozzle

Q mixing nozzle

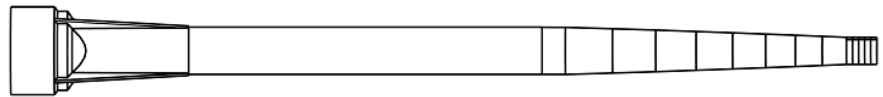

QH mixing nozzle

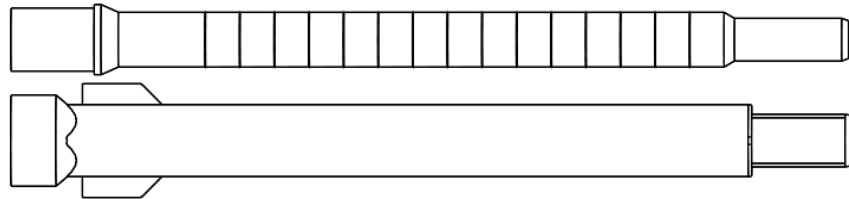

EZ-Flow mixing nozzle



ICFS CM 385 PE PRO, ICFS CM 585 PE PRO

Product description
Injection system

Annex A 2

Threaded rod M8, M10, M12, M16, M20, M24, M27, M30

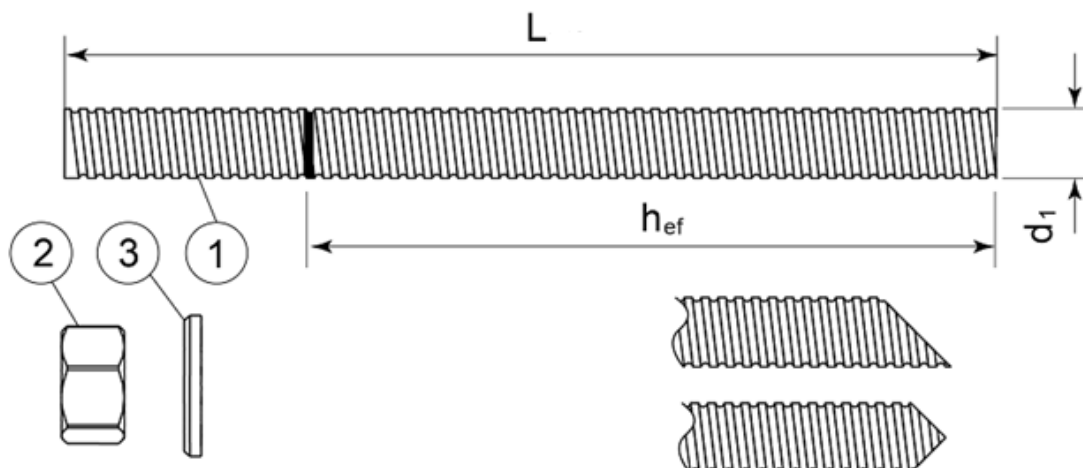

Standard commercial threaded rod with marked embedment depth

Part	Designation	Material
Steel, zinc plated $\geq 5 \mu\text{m}$ acc. to EN ISO 4042 or Steel, Hot-dip galvanized $\geq 40 \mu\text{m}$ acc. to EN ISO 1461 and EN ISO 10684 or Steel, zinc diffusion coating $\geq 15 \mu\text{m}$ acc. to EN 13811		
1	Anchor rod	Steel, EN 10087 or EN 10263 Property class 4.6, 4.8, 5.8, 8.8, 10.9* EN ISO 898-1
2	Hexagon nut EN ISO 4032	According to threaded rod, EN 20898-2
3	Washer EN ISO 887, EN ISO 7089, EN ISO 7093 or EN ISO 7094	According to threaded rod
Stainless steel		
1	Anchor rod	Material: A2-70, A4-70, A4-80, EN ISO 3506
2	Hexagon nut EN ISO 4032	According to threaded rod
3	Washer EN ISO 887, EN ISO 7089, EN ISO 7093 or EN ISO 7094	According to threaded rod
High corrosion resistant steel		
1	Anchor rod	Material: 1.4529, 1.4565, EN 10088-1
2	Hexagon nut EN ISO 4032	According to threaded rod
3	Washer EN ISO 887, EN ISO 7089, EN ISO 7093 or EN ISO 7094	According to threaded rod

*Galvanized rod of high strength are sensitive to hydrogen induced brittle failure

ICFS CM 385 PE PRO, ICFS CM 585 PE PRO	Annex A 3
Product description Threaded rod and materials	

Rebar Ø8, Ø10, Ø12, Ø16, Ø20, Ø25, Ø32



Standard commercial reinforcing bar with marked embedment depth

Product form		Bars and de-coiled rods	
Class		B	C
Characteristic yield strength f_{yk} or $f_{0,2k}$ (MPa)		400 to 600	
Minimum value of $k = (f_t/f_y)_k$		$\geq 1,08$	$\geq 1,15$ < 1,35
Characteristic strain at maximum force ϵ_{uk} (%)		$\geq 5,0$	$\geq 7,5$
Bendability		Bend/Rebend test	
Maximum deviation from nominal mass (individual bar) (%)	Nominal bar size (mm)	$\pm 6,0$ $\pm 4,5$	
	≤ 8 > 8		
Bond: Minimum relative rib area, $f_{R,min}$	Nominal bar size (mm)	0,040 0,056	
	8 to 12 > 12		

ICFS CM 385 PE PRO, ICFS CM 585 PE PRO

Product description
Rebars and materials

Annex A 4

Specifications of intended use

Anchorage subject to:

- Static and quasi-static load
- Seismic actions category C1 (max w = 0,5 mm):
 - threaded rod size M8, M10, M12, M16, M20, M24, M27, M30
 - rebar size Ø10, Ø12, Ø16, Ø20, Ø25, Ø32
- Seismic actions category C2 (max w = 0,8 mm): threaded rod size M12, M16, M20

Base materials

- Cracked and uncracked concrete
- Reinforced or unreinforced normal weight concrete of strength class C20/25 at minimum and C50/60 at maximum according EN 206:2013.

Temperature range:

- T3: -40°C to +70°C (max. short. term temperature +70°C and max. long term temperature +50°C)

Use conditions (Environmental conditions)

- (X1) Structures subject to dry internal conditions (zinc coated steel, stainless steel, high corrosion resistance steel).
- (X2) Structures subject to external atmospheric exposure (including industrial and marine environment) and to permanently damp internal condition, if no particular aggressive conditions exist (stainless steel A4, high corrosion resistant steel).
- (X3) Structures subject to external atmospheric exposure and to permanently damp internal condition, if other particular aggressive conditions exist (high corrosion resistant steel).

Note: *Particular aggressive conditions are e.g. permanent, alternating immersion in seawater or the splash zone of seawater, chloride atmosphere of indoor swimming pools or atmosphere with extreme chemical pollution (e.g. in desulphurization plants or road tunnels where de-icing materials are used).*

Concrete conditions:

- I1 – installation in dry or wet (water saturated) concrete and use in service in dry or wet concrete.
- I2 – installation in water-filled (not sea water) and use in service in dry or wet concrete

Design:

- The anchorages are designed in accordance with the EN 1992-4 under the responsibility of an engineer experienced in anchorages and concrete work.
- Verifiable calculation notes and drawings are prepared taking account of the loads to be anchored. The position of the anchor is indicated on the design drawings.
- Anchorages under seismic actions (cracked concrete) have to be designed in accordance with EN 1992-4.

Installation:

- Hole drilling by hammer drill mode.
- Anchor installation carried out by appropriately qualified personnel and under the supervision of the person responsible for technical matters of the site.

Installation direction:

- D3 – downward and horizontal and upwards (e.g. overhead) installation

ICFS CM 385 PE PRO, ICFS CM 585 PE PRO

Intended use
Specifications

Annex B 1

Applicator gun

A



B



C



D

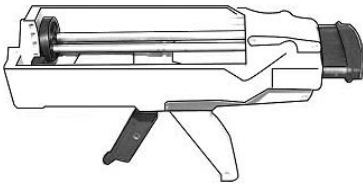

Cartridge	Applicator gun
Side by Side 385	A, B, C
Side by Side 585	D

Cleaning steel brush



Brush extensions

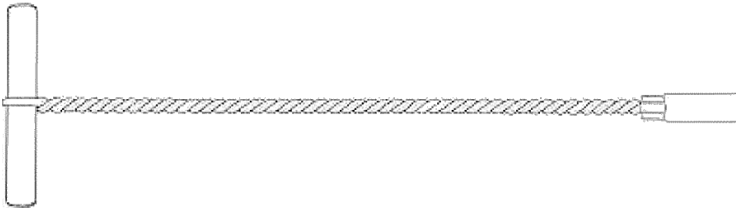

ICFS CM 385 PE PRO, ICFS CM 585 PE PRO

Intended use
 Applicator guns
 Cleaning brush

Annex B 2

Installation instructions

Before commencing installation ensure the operative is equipped with appropriate personal protection equipment, SDS Hammer Drill, Air, Hole Cleaning Brush, good quality Dispensing Tool – either manual or power operated, Chemical cartridge with mixing nozzle and extension tube, if needed.

- Using the SDS Hammer Drill in rotary hammer mode for drilling, with a carbide tipped drill bit of the appropriate size, drill the hole to the specified hole diameter and depth.

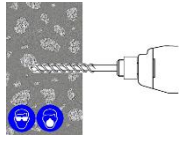

- Insert the Air Lance to the bottom of the hole and depress the trigger for 2 seconds. The compressed air must be clean – free from water and oil – and at a minimum pressure of 6bar.

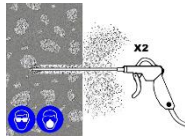

Perform the blowing operation twice.

- Select the correct size Hole Cleaning Brush. Ensure that the brush is in good condition and the correct diameter. Insert the brush to the bottom of the hole, using a brush

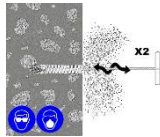

extension if needed to reach the bottom of the hole and withdraw with a twisting motion. *There should be positive interaction between the steel bristles of the brush and the sides of the drilled hole.*

Perform the brushing operation twice.

- Repeat 2

- Repeat 3

- Repeat 2

- Select the appropriate static mixer nozzle, checking that the mixing elements are present and correct (**do not modify the mixer**). Attach mixer nozzle to the cartridge. Check the Dispensing Tool is in good working order. Place the cartridge into the dispensing tool.

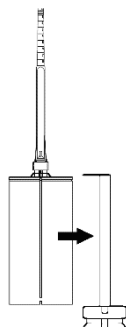

Note: The QH nozzle is in two sections. One section contains the mixing elements and the other section is an extension piece. Connect the extension piece to the mixing section by pushing the two sections firmly together until a positive engagement is felt.

- Extrude some resin to waste until an even-colored mixture is extruded, The cartridge is now ready for use



- Attach an extension tube with resin stopper (if required) to the end of the mixing nozzle with a push fit

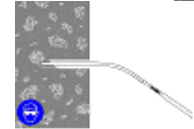

(The extension tubes may be pushed into the resin stoppers and are held in place with a coarse internal thread).

- Insert the mixing nozzle to the bottom of the hole. Extrude the resin and slowly withdraw the nozzle from the hole.

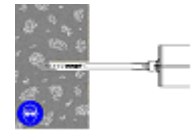

Ensure no air voids are created as the nozzle is withdrawn. Inject resin until the hole is approximately $\frac{3}{4}$ full and remove the nozzle from the hole.

- Select the steel anchor element ensuring it is free from oil or other contaminants, and mark with the required embedment depth. Insert the steel element into the hole using a back and forth twisting motion to ensure complete cover, until it reaches the bottom of the hole. Excess resin will be expelled from the hole evenly around the steel element and there shall be no gaps between the anchor element and the wall of the drilled hole.



- Clean any excess resin from around the mouth of the hole.

- Do not disturb the anchor until at least the minimum cure time has elapsed. Refer to the Working and Load Timetable to determine the appropriate cure time.

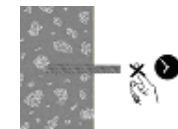

- Position the fixture and tighten the anchor to the appropriate installation torque.



Do not over-torque the anchor as this could adversely affect its performance.

ICFS CM 385 PE PRO, ICFS CM 585 PE PRO

Intended use
Installation procedure

Annex B 3

Installation instructions

Overhead Substrate Installation Method

- Using the SDS Hammer Drill in rotary hammer mode for drilling, with a carbide tipped drill bit of the appropriate size, drill the hole to the specified hole diameter and depth.

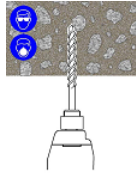

- Select the correct Air Lance, insert to the bottom of the hole and depress the trigger for 2 seconds. The compressed air must be clean – free from water and oil – and at a minimum pressure of 90psi (6bar).

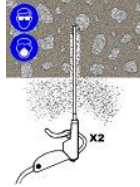

Perform the blowing operation twice.

- Select the correct size Hole Cleaning Brush. Ensure that the brush is in good condition and the correct diameter. Insert the brush to the bottom of the hole, using a brush extension if needed to reach the bottom of the hole, and withdraw with a twisting motion. *There should be positive interaction between the steel bristles of the brush and the sides of the drilled hole.*

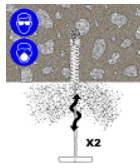

Perform the brushing operation twice.

- Repeat 2
- Repeat 3
- Repeat 2
- Select the appropriate static mixer nozzle checking that the mixing elements are present and correct (**do not modify the mixer**). Attach mixer nozzle to the cartridge. Check the Dispensing Tool is in good working order. Place the cartridge into the dispensing tool.

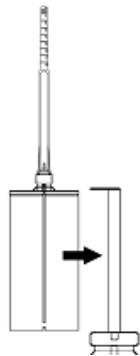

Note: The QH nozzle is in two sections. One section contains the mixing elements and the other section is an extension piece. Connect the extension piece to the mixing section by pushing the two sections firmly together until a positive engagement is felt.

- Extrude some resin to waste until an even-colored mixture is extruded, The cartridge is now ready for use.



- Attach an extension tube with resin stopper (if required) to the end of the mixing nozzle with a push fit. (The extension tubes may be pushed into the resin stoppers and are held in place with a coarse internal thread).

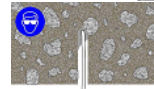

- Insert the mixing nozzle to the bottom of the hole. Extrude the resin and slowly withdraw the nozzle from the hole. **Ensure no air voids are created** as the nozzle is withdrawn. Inject resin until the hole is approximately ¾ full and remove the nozzle from the hole.



- Select the steel anchor element ensuring it is free from oil or other contaminants, and mark with the required embedment depth. Insert the steel element into the hole using a back and forth twisting motion to ensure complete cover, until it reaches the bottom of the hole.



Excess resin will be expelled from the hole evenly around the steel element and there shall be no gaps between the anchor element and the wall of the drilled hole.

- Clean any excess resin from around the mouth of the hole.
- Do not disturb the anchor until at least the minimum cure time has elapsed. Refer to the Working and Load Timetable to determine the appropriate cure time.



- Position the fixture and tighten the anchor to the appropriate installation torque.



Do not over-torque the anchor as this could adversely affect its performance.

ICFS CM 385 PE PRO, ICFS CM 585 PE PRO

Intended use
Installation procedure

Annex B 4

Table B1: Installation parameters of threaded rod

Size		M8	M10	M12	M16	M20	M24	M27	M30
Nominal drill hole diameter	$\varnothing d_0$ [mm]	10	12	14	18	22	26	30	35
Cleaning brush		S11HF	S14HF	S14/15HF	S22HF	S24HF	S31HF	S31HF	S38HF
Torque moment	$\max T_{\text{fixt}}$ [Nm]	10	20	40	80	120	160	180	200
Embedment depth for $h_{\text{ef,min}}$	h_{ef} [mm]	60	60	70	80	90	96	108	120
Embedment depth for $h_{\text{ef,max}}$	h_{ef} [mm]	160	200	240	320	400	480	540	600
Depth of drill hole	h_0 [mm]	$h_{\text{ef}}+5$	$h_{\text{ef}}+5$	$h_{\text{ef}}+5$	$h_{\text{ef}}+5$	$h_{\text{ef}}+5$	$h_{\text{ef}}+5$	$h_{\text{ef}}+5$	$h_{\text{ef}}+5$
Minimum edge distance	c_{min} [mm]	40	40	40	40	50	50	50	60
Minimum spacing	s_{min} [mm]	40	40	40	40	50	50	50	60
Minimum thickness of member	h_{min} [mm]	$h_{\text{ef}} + 30 \text{ mm} \geq 100 \text{ mm}$			$h_{\text{ef}} + 2d_0$				

Table B2: Installation parameters of rebar

Size		Ø8	Ø10	Ø12	Ø16	Ø20	Ø25	Ø32
Nominal drill hole diameter	$\varnothing d_0$ [mm]	12	14	16	20	25	32	40
Cleaning brush		S12/13HF	S14/15HF	S18HF	S22HF	S27HF	S35HF	S43HF
Torque moment	$\max T_{\text{fixt}}$ [Nm]	10	20	40	80	120	180	200
Embedment depth for $h_{\text{ef,min}}$	h_{ef} [mm]	60	60	70	80	90	100	128
Embedment depth for $h_{\text{ef,max}}$	h_{ef} [mm]	160	200	240	320	400	500	640
Depth of drill hole	h_0 [mm]	$h_{\text{ef}}+5$	$h_{\text{ef}}+5$	$h_{\text{ef}}+5$	$h_{\text{ef}}+5$	$h_{\text{ef}}+5$	$h_{\text{ef}}+5$	$h_{\text{ef}}+5$
Minimum edge distance	c_{min} [mm]	40	40	40	40	50	50	70
Minimum spacing	s_{min} [mm]	40	40	40	40	50	50	70
Minimum thickness of member	h_{min} [mm]	$h_{\text{ef}} + 30 \text{ mm} \geq 100 \text{ mm}$			$h_{\text{ef}} + 2d_0$			

Table B3: Minimum curing time

Base Material Temperature [°C]	Cartridge Temperature [°C]	T Work [mins]	T Load [hrs]
+5	Minimum +10	300	24
+5°C to +10		150	
+10°C to +15	+10°C to +15	40	18
+15°C to +20	+15°C to +20	25	12
+20°C to +25	+20°C to +25	18	8
+25°C to +30	+25°C to +30	12	6
+30°C to +35	+30°C to +35	8	4
+35°C to +40	+35°C to +40	6	2
Ensure cartridge is $\geq 10^\circ\text{C}$			

T Work is typical gel time at highest base material temperature in the range.

T Load is minimum set time required until load can be applied at the lowest temperature in the range.

ICFS CM 385 PE PRO, ICFS CM 585 PE PRO

Intended use
Installation parameters
Curing time

Annex B 5

Table C1: Design method EN 1992-4

Characteristic values of resistance to tension load of threaded rod

Steel failure – Characteristic resistance										
Size			M8	M10	M12	M16	M20	M24	M27	M30
Steel grade 4.6	$N_{Rk,s}$	[kN]	15	23	34	63	98	141	184	224
Partial safety factor	γ_{Ms}	[-]	2,00							
Steel grade 4.8	$N_{Rk,s}$	[kN]	15	23	34	63	98	141	184	224
Partial safety factor	γ_{Ms}	[-]	1,50							
Steel grade 5.8	$N_{Rk,s}$	[kN]	18	29	42	79	123	177	230	281
Partial safety factor	γ_{Ms}	[-]	1,50							
Steel grade 8.8	$N_{Rk,s}$	[kN]	29	46	67	126	196	282	367	449
Partial safety factor	γ_{Ms}	[-]	1,50							
Steel grade 10.9	$N_{Rk,s}$	[kN]	37	58	84	157	245	353	459	561
Partial safety factor	γ_{Ms}	[-]	1,33							
Stainless steel grade A2-70, A4-70	$N_{Rk,s}$	[kN]	26	41	59	110	172	247	321	393
Partial safety factor	γ_{Ms}	[-]	1,87							
Stainless steel grade A4-80	$N_{Rk,s}$	[kN]	29	46	67	126	196	282	367	449
Partial safety factor	γ_{Ms}	[-]	1,60							
Stainless steel grade 1.4529	$N_{Rk,s}$	[kN]	26	41	59	110	172	247	321	393
Partial safety factor	γ_{Ms}	[-]	1,50							
Stainless steel grade 1.4565	$N_{Rk,s}$	[kN]	26	41	59	110	172	247	321	393
Partial safety factor	γ_{Ms}	[-]	1,87							
Combined pullout and concrete cone failure in concrete C20/25 for a working life of 50 years and 100 years										
Size			M8	M10	M12	M16	M20	M24	M27	M30
Characteristic bond resistance in uncracked concrete										
Temperature T3: -40°C to +70°C	$\tau_{Rk,ucr}$	[N/mm ²]	14	13	13	12	12	11	10	9
Dry, wet concrete, flooded hole										
Partial safety factor	γ_{inst}	[-]	1,0							
Characteristic bond resistance in cracked concrete										
Temperature T3: -40°C to +70°C	$\tau_{Rk,cr}$	[N/mm ²]	8	8	7,5	7,5	7	7	5	5
Dry, wet concrete, flooded hole										
Partial safety factor	γ_{inst}	[-]	1,0							
Factor for influence of sustained load for a working life 50 years	T3: 50°C / 70°C	ψ^0_{sus}	[-]		0,72					
Factor for concrete	C25/30	ψ_c	[-]		1,02					
	C30/37				1,04					
	C35/45				1,06					
	C40/50				1,07					
	C45/55				1,08					
	C50/60	1,09								
Concrete cone failure										
Factor for concrete cone failure for uncracked concrete	$k_{ucr,N}$	[-]		11						
Factor for concrete cone failure for cracked concrete	$k_{cr,N}$			7,7						
Edge distance	$C_{cr,N}$	[mm]	1,5h _{ef}							
Splitting failure										
Size			M8	M10	M12	M16	M20	M24	M27	M30
Edge distance	$C_{cr,sp}$	[mm]	2 • h _{ef}							
Spacing	$S_{cr,sp}$	[mm]	2 • C _{cr,sp}							

ICFS CM 385 PE PRO, ICFS CM 585 PE PRO

Performances

Design according to EN 1992-4

Characteristic resistance for tension loads - threaded rod

Annex C 1

Table C2: Design method EN 1992-4
Characteristic values of resistance to tension load of rebar

Steel failure – Characteristic resistance								
Size		Ø8	Ø10	Ø12	Ø16	Ø20	Ø25	Ø32
Rebar BSt 500 S	$N_{Rk,s}$ [kN]	28	43	62	111	173	270	442
Partial safety factor	γ_{Ms} [-]	1,4						

Combined pullout and concrete cone failure in concrete C20/25 for a working life of 50 years and 100 years								
Size		Ø8	Ø10	Ø12	Ø16	Ø20	Ø25	Ø32
Characteristic bond resistance in uncracked concrete								
Temperature T3: -40°C to +70°C	$\tau_{Rk,ucr}$ [N/mm ²]	12	12	12	11	11	11	7
Dry and wet concrete								
Installation safety factor	γ_{inst} [-]	1,0						
Flooded hole								
Installation safety factor	γ_{inst} [-]	1,2						
Characteristic bond resistance in cracked concrete								
Temperature T3: -40°C to +70°C	$\tau_{Rk,cr}$ [N/mm ²]	7	10	9	9	8	8	5
Dry and wet concrete								
Installation safety factor	γ_{inst} [-]	1,0						
Flooded hole								
Installation safety factor	γ_{inst} [-]	1,2						
Factor for influence of sustained load for a working life 50 years	T3: 50°C / 70°C ψ^0_{sus} [-]	0,72						
Factor for concrete	C25/30 C30/37 C35/45 C40/50 C45/55 C50/60 ψ_c [-]	1,02 1,04 1,06 1,07 1,08 1,09						

Concrete cone failure			
Factor for concrete cone failure for uncracked concrete	$k_{ucr,N}$	[-]	11
Factor for concrete cone failure for cracked concrete	$k_{cr,N}$		7,7
Edge distance	$c_{cr,N}$ [mm]		1,5 h_{ef}

Splitting failure								
Size		Ø8	Ø10	Ø12	Ø16	Ø20	Ø25	Ø32
Edge distance	$c_{cr,sp}$ [mm]	2 • h_{ef}						
Spacing	$s_{cr,sp}$ [mm]	2 • $c_{cr,sp}$						

ICFS CM 385 PE PRO, ICFS CM 585 PE PRO

Performances

Design according to EN 1992-4
Characteristic resistance for tension loads - rebar

Annex C 2

Table C3: Design method EN 1992-4
Characteristic values of resistance to shear load of threaded rod

Steel failure without lever arm											
Size			M8	M10	M12	M16	M20	M24	M27	M30	
Steel grade 4.6	$V_{Rk,s}$	[kN]	7	12	17	31	49	71	92	112	
Partial safety factor	γ_{Ms}	[-]	1,67								
Steel grade 4.8	$V_{Rk,s}$	[kN]	7	12	17	31	49	71	92	112	
Partial safety factor	γ_{Ms}	[-]	1,25								
Steel grade 5.8	$V_{Rk,s}$	[kN]	9	15	21	39	61	88	115	140	
Partial safety factor	γ_{Ms}	[-]	1,25								
Steel grade 8.8	$V_{Rk,s}$	[kN]	15	23	34	63	98	141	184	224	
Partial safety factor	γ_{Ms}	[-]	1,25								
Steel grade 10.9	$V_{Rk,s}$	[kN]	18	29	42	79	123	177	230	281	
Partial safety factor	γ_{Ms}	[-]	1,5								
Stainless steel grade A2-70, A4-70	$V_{Rk,s}$	[kN]	13	20	30	55	86	124	161	196	
Partial safety factor	γ_{Ms}	[-]	1,56								
Stainless steel grade A4-80	$V_{Rk,s}$	[kN]	15	23	34	63	98	141	184	224	
Partial safety factor	γ_{Ms}	[-]	1,33								
Stainless steel grade 1.4529	$V_{Rk,s}$	[kN]	13	20	30	55	86	124	161	196	
Partial safety factor	γ_{Ms}	[-]	1,25								
Stainless steel grade 1.4565	$V_{Rk,s}$	[kN]	13	20	30	55	86	124	161	196	
Partial safety factor	γ_{Ms}	[-]	1,56								
Characteristic resistance of group of fasteners											
Ductility factor $k_7 = 1,0$ for steel with rupture elongation $A_5 > 8\%$											

Steel failure with lever arm											
Size			M8	M10	M12	M16	M20	M24	M27	M30	
Steel grade 4.6	$M^o_{Rk,s}$	[N.m]	15	30	52	133	260	449	666	900	
Partial safety factor	γ_{Ms}	[-]	1,67								
Steel grade 4.8	$M^o_{Rk,s}$	[N.m]	15	30	52	133	260	449	666	900	
Partial safety factor	γ_{Ms}	[-]	1,25								
Steel grade 5.8	$M^o_{Rk,s}$	[N.m]	19	37	66	166	325	561	832	1125	
Partial safety factor	γ_{Ms}	[-]	1,25								
Steel grade 8.8	$M^o_{Rk,s}$	[N.m]	30	60	105	266	519	898	1332	1799	
Partial safety factor	γ_{Ms}	[-]	1,25								
Steel grade 10.9	$M^o_{Rk,s}$	[N.m]	37	75	131	333	649	1123	1664	2249	
Partial safety factor	γ_{Ms}	[-]	1,50								
Stainless steel grade A2-70, A4-70	$M^o_{Rk,s}$	[N.m]	26	52	92	233	454	786	1165	1574	
Partial safety factor	γ_{Ms}	[-]	1,56								
Stainless steel grade A4-80	$M^o_{Rk,s}$	[N.m]	30	60	105	266	519	898	1332	1799	
Partial safety factor	γ_{Ms}	[-]	1,33								
Stainless steel grade 1.4529	$M^o_{Rk,s}$	[N.m]	26	52	92	233	454	786	1165	1574	
Partial safety factor	γ_{Ms}	[-]	1,25								
Stainless steel grade 1.4565	$M^o_{Rk,s}$	[N.m]	26	52	92	233	454	786	1165	1574	
Partial safety factor	γ_{Ms}	[-]	1,56								
Concrete pryout failure											
Factor for resistance to pry-out failure	k_8	[-]	2								

Concrete edge failure											
Size			M8	M10	M12	M16	M20	M24	M27	M30	
Outside diameter of fastener	d_{nom}	[mm]	8	10	12	16	20	24	27	30	
Effective length of fastener	l_f	[mm]	min (h_{ef} , $8 d_{nom}$)								

ICFS CM 385 PE PRO, ICFS CM 585 PE PRO

Performances

Design according to EN 1992-4
Characteristic resistance for shear loads - threaded rod

Annex C 3

Table C4: Design method EN 1992-4
Characteristic values of resistance to shear load of rebar

Steel failure without lever arm										
Size			Ø8	Ø10	Ø12	Ø16	Ø20	Ø25	Ø32	
Rebar BSt 500 S	$V_{Rk,S}$	[kN]	14	22	31	55	86	135	221	
Partial safety factor	γ_{Ms}	[-]	1,5							
Characteristic resistance of group of fasteners										
Ductility factor	$k_7 = 1,0$ for steel with rupture elongation $A_5 > 8\%$									

Steel failure with lever arm										
Size			Ø8	Ø10	Ø12	Ø16	Ø20	Ø25	Ø32	
Rebar BSt 500 S	$M^o_{Rk,S}$	[N.m]	33	65	112	265	518	1013	2122	
Partial safety factor	γ_{Ms}	[-]	1,5							
Concrete pryout failure										
Factor for resistance to pry-out failure	k_8	[-]	2							

Concrete edge failure										
Size			Ø8	Ø10	Ø12	Ø16	Ø20	Ø25	Ø32	
Outside diameter of fastener	d_{nom}	[mm]	8	10	12	16	20	25	32	
Effective length of fastener	l_f	[mm]	min ($h_{ef}, 8 d_{nom}$)							

ICFS CM 385 PE PRO, ICFS CM 585 PE PRO

Performances
Design according to EN 1992-4
Characteristic resistance for shear loads - rebar

Annex C 4

Table C5: Displacement of threaded rod under tension and shear load

Size		M8	M10	M12	M16	M20	M24	M27	M30
Tension load									
Uncracked concrete									
δ_{N0}	[mm/kN]	0,03	0,02	0,02	0,02	0,01	0,01	0,01	0,01
$\delta_{N\infty}$	[mm/kN]	0,05	0,04	0,03	0,03	0,02	0,02	0,01	0,01
Cracked concrete									
δ_{N0}	[mm/kN]	0,05	0,04	0,03	0,03	0,02	0,02	0,02	0,02
$\delta_{N\infty}$	[mm/kN]	0,35	0,21	0,14	0,12	0,08	0,07	0,07	0,07
Shear load									
δ_{V0}	[mm/kN]	0,71	0,45	0,31	0,17	0,11	0,07	0,06	0,05
$\delta_{V\infty}$	[mm/kN]	1,06	0,67	0,46	0,25	0,16	0,11	0,08	0,07

Table C6: Displacement of rebar under tension and shear load

Size		Ø8	Ø10	Ø12	Ø16	Ø20	Ø25	Ø32
Tension load								
Uncracked concrete								
δ_{N0}	[mm/kN]	0,04	0,03	0,02	0,01	0,01	0,01	0,01
$\delta_{N\infty}$	[mm/kN]	0,08	0,05	0,04	0,02	0,02	0,01	0,01
Cracked concrete								
δ_{N0}	[mm/kN]	0,05	0,04	0,03	0,03	0,02	0,02	0,02
$\delta_{N\infty}$	[mm/kN]	0,35	0,21	0,17	0,11	0,08	0,07	0,06
Shear load								
δ_{V0}	[mm/kN]	0,38	0,24	0,17	0,10	0,06	0,04	0,02
$\delta_{V\infty}$	[mm/kN]	0,56	0,36	0,25	0,14	0,09	0,06	0,04

ICFS CM 385 PE PRO, ICFS CM 585 PE PRO

Performances
Displacement for threaded rod and rebar

Annex C 5

Table C7: Seismic performance category C1 of threaded rod

Size			M8	M10	M12	M16	M20	M24	M27	M30
Tension load										
Steel failure										
Characteristic resistance grade 4.6	$N_{Rk,s,eq,C1}$	[kN]	15	23	34	63	98	141	184	224
Partial safety factor	γ_{Ms}	[-]	2,00							
Characteristic resistance grade 4.8	$N_{Rk,s,eq,C1}$	[kN]	15	23	34	63	98	141	184	224
Partial safety factor	γ_{Ms}	[-]	1,50							
Characteristic resistance grade 5.8	$N_{Rk,s,eq,C1}$	[kN]	18	29	42	79	123	177	230	281
Partial safety factor	γ_{Ms}	[-]	1,50							
Characteristic resistance grade 8.8	$N_{Rk,s,eq,C1}$	[kN]	29	46	67	126	196	282	367	449
Partial safety factor	γ_{Ms}	[-]	1,50							
Characteristic resistance grade 10.9	$N_{Rk,s,eq,C1}$	[kN]	37	58	84	157	245	353	459	561
Partial safety factor	γ_{Ms}	[-]	1,33							
Characteristic resistance A2-70, A4-70	$N_{Rk,s,eq,C1}$	[kN]	26	41	59	110	172	247	321	393
Partial safety factor	γ_{Ms}	[-]	1,87							
Characteristic resistance A4-80	$N_{Rk,s,eq,C1}$	[kN]	29	46	67	126	196	282	367	449
Partial safety factor	γ_{Ms}	[-]	1,60							
Characteristic resistance 1.4529	$N_{Rk,s,eq,C1}$	[kN]	26	41	59	110	172	247	321	393
Partial safety factor	γ_{Ms}	[-]	1,50							
Characteristic resistance 1.4565	$N_{Rk,s,eq,C1}$	[kN]	26	41	59	110	172	247	321	393
Partial safety factor	γ_{Ms}	[-]	1,87							
Combined pullout and concrete cone failure in concrete C20/25 for a working life of 50 years and 100 years										
Characteristic bond resistance										
Temperature T3: -40°C to +70°C	$\tau_{Rk,p,eq,C1}$	[N/mm ²]	8,0	8,0	7,5	7,5	7,0	7,0	5,0	4,5
Installation safety factor	γ_{inst}	[-]	1,0							
Shear load										
Steel failure without lever arm										
Characteristic resistance grade 4.6	$V_{Rk,s,eq,C1}$	[kN]	5	9	13	20	32	28	37	45
Partial safety factor	γ_{Ms}	[-]	1,67							
Characteristic resistance grade 4.8	$V_{Rk,s,eq,C1}$	[kN]	5	9	13	20	32	28	37	45
Partial safety factor	γ_{Ms}	[-]	1,25							
Characteristic resistance grade 5.8	$V_{Rk,s,eq,C1}$	[kN]	7	11	16	26	40	35	46	56
Partial safety factor	γ_{Ms}	[-]	1,25							
Characteristic resistance grade 8.8	$V_{Rk,s,eq,C1}$	[kN]	11	17	25	41	64	56	73	90
Partial safety factor	γ_{Ms}	[-]	1,25							
Characteristic resistance grade 10.9	$V_{Rk,s,eq,C1}$	[kN]	14	22	32	51	80	71	92	112
Partial safety factor	γ_{Ms}	[-]	1,50							
Characteristic resistance A2-70, A4-70	$V_{Rk,s,eq,C1}$	[kN]	10	15	22	36	56	49	64	79
Partial safety factor	γ_{Ms}	[-]	1,56							
Characteristic resistance A4-80	$V_{Rk,s,eq,C1}$	[kN]	11	17	25	41	64	56	73	90
Partial safety factor	γ_{Ms}	[-]	1,33							
Characteristic resistance 1.4529	$V_{Rk,s,eq,C1}$	[kN]	10	15	22	36	56	49	64	79
Partial safety factor	γ_{Ms}	[-]	1,25							
Characteristic resistance 1.4565	$V_{Rk,s,eq,C1}$	[kN]	10	15	22	36	56	49	64	79
Partial safety factor	γ_{Ms}	[-]	1,56							
Characteristic shear load resistance $V_{Rk,s,eq}$ in the Table C7 shall be multiplied by following reduction factor for hot-dip galvanized commercial standard rods										
Reduction factor for hot-dip galvanized rods	$\alpha_{v,h-dg,c1}$	[-]	0,47	0,47	0,47	0,54	0,54	0,88	0,88	0,88
Factor for annular gap	α_{gap}	[-]	0,5							

The anchor shall be used with minimum rupture elongation after fracture A_5 equal to 19%.

ICFS CM 385 PE PRO, ICFS CM 585 PE PRO

Performances
Seismic performance category C1 of threaded rod

Annex C 6

Table C8: Seismic performance category C1 of rebar

Size			Ø10	Ø12	Ø16	Ø20	Ø25	Ø32
Tension load								
Steel failure								
Rebar BSt 500 S	$N_{Rk,s,eq,C1}$	[kN]	43	62	111	173	270	442
Partial safety factor	γ_{Ms}	[-]	1,4					
Combined pullout and concrete cone failure in concrete C20/25 for a working life of 50 years and 100 years								
Temperature T3: -40°C to +70°C	$\tau_{Rk,p,eq,C1}$	[N/mm ²]	8,9	9,0	9,0	8,0	7,5	4,8
Dry and wet concrete								
Installation safety factor	γ_{inst}	[-]	1,0					
Flooded hole								
Installation safety factor	γ_{inst}	[-]	1,2					
Shear load								
Steel failure without lever arm								
Rebar BSt 500 S	$V_{Rk,s,eq,C1}$	[kN]	16	23	41	69	67	111
Partial safety factor	γ_{Ms}	[-]	1,5					
Factor for annular gap	α_{gap}	[-]	0,5					

ICFS CM 385 PE PRO, ICFS CM 585 PE PRO

Performances
Seismic performance category C1 of rebar

Annex C 7

Table C9: Seismic performance category C2 of threaded rod

Size			M12	M16	M20
Tension load					
Steel failure					
Characteristic resistance grade 4.6	$N_{Rk,s,eq,C2}$	[kN]	34	63	98
Partial safety factor	γ_{Ms}	[-]		2,00	
Characteristic resistance grade 4.8	$N_{Rk,s,eq,C2}$	[kN]	34	63	98
Partial safety factor	γ_{Ms}	[-]		1,50	
Characteristic resistance grade 5.8	$N_{Rk,s,eq,C2}$	[kN]	42	79	123
Partial safety factor	γ_{Ms}	[-]		1,50	
Characteristic resistance grade 8.8	$N_{Rk,s,eq,C2}$	[kN]	67	126	196
Partial safety factor	γ_{Ms}	[-]		1,50	
Characteristic resistance grade 10.9	$N_{Rk,s,eq,C2}$	[kN]	84	157	245
Partial safety factor	γ_{Ms}	[-]		1,33	
Characteristic resistance A2-70, A4-70	$N_{Rk,s,eq,C2}$	[kN]	59	110	172
Partial safety factor	γ_{Ms}	[-]		1,87	
Characteristic resistance A4-80	$N_{Rk,s,eq,C2}$	[kN]	67	126	196
Partial safety factor	γ_{Ms}	[-]		1,60	
Characteristic resistance 1.4529	$N_{Rk,s,eq,C2}$	[kN]	59	110	172
Partial safety factor	γ_{Ms}	[-]		1,50	
Characteristic resistance 1.4565	$N_{Rk,s,eq,C2}$	[kN]	59	110	172
Partial safety factor	γ_{Ms}	[-]		1,87	
Combined pullout and concrete cone failure in concrete C20/25 for a working life of 50 years and 100 years					
Characteristic bond resistance					
Temperature T3: -40°C to +70°C	$\tau_{Rk,p,eq,C2}$	[N/mm ²]	3,2	3,7	4,2
Installation safety factor	γ_{inst}	[-]		1,0	
Shear load					
Steel failure without lever arm					
Characteristic resistance grade 4.6	$V_{Rk,s,eq,C2}$	[kN]	13	18	28
Partial safety factor	γ_{Ms}	[-]		1,67	
Characteristic resistance grade 4.8	$V_{Rk,s,eq,C2}$	[kN]	13	18	28
Partial safety factor	γ_{Ms}	[-]		1,25	
Characteristic resistance grade 5.8	$V_{Rk,s,eq,C2}$	[kN]	16	22	35
Partial safety factor	γ_{Ms}	[-]		1,25	
Characteristic resistance grade 8.8	$V_{Rk,s,eq,C2}$	[kN]	25	36	56
Partial safety factor	γ_{Ms}	[-]		1,25	
Characteristic resistance grade 10.9	$V_{Rk,s,eq,C2}$	[kN]	32	45	70
Partial safety factor	γ_{Ms}	[-]		1,50	
Characteristic resistance A2-70, A4-70	$V_{Rk,s,eq,C2}$	[kN]	22	31	49
Partial safety factor	γ_{Ms}	[-]		1,56	
Characteristic resistance A4-80	$V_{Rk,s,eq,C2}$	[kN]	25	36	56
Partial safety factor	γ_{Ms}	[-]		1,33	
Characteristic resistance 1.4529	$V_{Rk,s,eq,C2}$	[kN]	22	31	49
Partial safety factor	γ_{Ms}	[-]		1,25	
Characteristic resistance 1.4565	$V_{Rk,s,eq,C2}$	[kN]	22	31	49
Partial safety factor	γ_{Ms}	[-]		1,56	
Characteristic shear load resistance $V_{Rk,s,eq}$ in the Table C9 shall be multiplied by following reduction factor for hot-dip galvanized commercial standard rods					
Reduction factor for hot-dip galvanized rods	$\alpha_{v,h-dg,c2}$	[-]	0,46	0,61	0,61
Factor for annular gap	α_{gap}	[-]		0,5	

Table C10: Displacement under tensile and shear load - seismic category C2 of threaded rod

Size		M12	M16	M20
$\delta_{N,eq}(DLS)$	[mm]	0,20	0,40	0,77
$\delta_{N,eq}(ULS)$	[mm]	0,76	0,74	1,68
$\delta_{V,eq}(DLS)$	[mm]	5,29	4,12	4,94
$\delta_{V,eq}(ULS)$	[mm]	10,20	9,05	10,99

The anchor shall be used with minimum rupture elongation after fracture A_5 equal to 19%.

ICFS CM 385 PE PRO, ICFS CM 585 PE PRO

Performances

Seismic performance category C2 of threaded rod

Annex C 8